

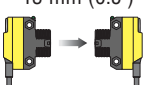
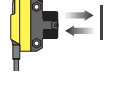
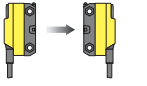
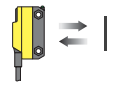
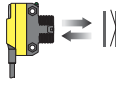
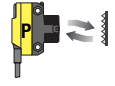
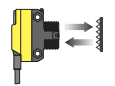
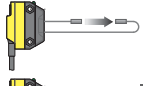
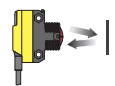
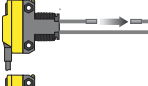

Features

- Easily fits (or retrofits) almost any mounting situation
- Exceptional optical performance, comparable to larger “MINI-style” or barrel sensors
- 10 to 30V dc operation, with complementary (SPDT) NPN or PNP outputs, depending on model
- Bright LED operating status indicators are visible from 360°
- Rugged sealed housing, protected circuitry
- Models available with or without 18 mm threaded “nose”
- Less than 1 millisecond output response for excellent sensing repeatability
- Choose 2 m (6.5') or 9 m (30') cable or 150 mm (6") Pico-style pigtail QD

Models

Sensing Mode		Model*	Range	Output	Sensing Mode		Model*	Range	Output	
Opposed	940 nm Infrared Effective Beam: 13 mm (0.5") 	QS186E	20 m (66')	N/A	Diffuse		QS18VN6D	450 mm (18")	NPN	
		QS18VN6R		NPN			QS18VP6D		PNP	
		QS18VP6R		PNP			QS18VN6DB	450 mm (18")	NPN	
	940 nm Infrared Effective Beam: 13 mm (0.5") 	QS186EB	3 m (10')	N/A	Divergent		QS18VN6W		100 mm (4")	NPN
		QS18VN6RB		NPN			QS18VP6W	PNP		
		QS18VP6RB		PNP			Fixed-Field		660 nm Visible Red	50 mm (2")
660 nm Visible Red 	QS18VN6LP	3.5 m (12')	NPN	QS18VP6FF50	PNP					
	QS18VP6LP		PNP	100 mm (4")	QS18VN6FF100	NPN				
660 nm Visible Red 	QS18VN6LV	6.5 m (21')	NPN		Plastic Fiber Optic				660 nm Visible Red	Range varies by sensing mode and fiber optics used
	QS18VP6LV		PNP	QS18VP6FP			PNP			
Convergent	660 nm Visible Red 	QS18VN6CV15	16 mm (0.63")	NPN	Glass Fiber Optic		940 nm Infrared	Range varies by sensing mode and fiber optics used	QS18VN6F	NPN
		QS18VP6CV15		PNP					QS18VP6F	PNP
		QS18VN6CV45	43 mm (1.7")	NPN						
		QS18VP6CV45		PNP						

* Only standard 2m (6.5') cable models are listed. For 9 m (30') cable, add suffix “W/30” to the model number (e.g., **QS186E W/30**).

QD models:

- For 4-pin integral Euro-style QD, add suffix “Q8” (e.g., **QS186EQ8**).
- For 4-pin integral Pico-style QD, add suffix “Q7” (e.g., **QS186EQ7**).
- For 4-pin 150 mm (6") Euro-style pigtail, add suffix “Q5” (e.g., **QS186EQ5**).
- For 4-pin 150 mm (6") Pico-style pigtail, add suffix “Q” (e.g., **QS186EQ**).

WORLD-BEAM® QS18

Specifications

Supply Voltage	10 to 30V dc (10% maximum ripple) at less than 25 mA, exclusive of load; Protected against reverse polarity and transient voltages		
Output Configuration	Solid-state complementary (SPDT); NPN or PNP (current sinking or sourcing), depending on model; Rating: 100 mA maximum each output at 25°C Off-state leakage current: FF Mode: less than 200 µA @ 30V dc All others: less than 50 µA @ 30V dc ON-state saturation voltage: less than 1V @ 10 mA; less than 1.5V @ 100 mA Protected against false pulse on power-up and continuous overload or short circuit of outputs		
Output Response	Opposed Mode: 750 microseconds ON; 375 microseconds OFF FF Mode: 850 microseconds ON/OFF All others: 600 microseconds ON/OFF NOTE: 100 millisecond delay on power-up; outputs do not conduct during this time		
Repeatability	Opposed Mode: 100 microseconds FF Mode: 160 microseconds All others: 150 microseconds		
Adjustments	Glass Fiber Optic, Plastic Fiber Optic, Convergent, Diffuse, and Retroreflective mode models (only): Single-turn sensitivity (Gain) adjustment potentiometer		
Indicators	2 LED indicators Green steady: Power ON Yellow* steady: Light sensed *NOTE: Prior to date code 0223, the output indicator was red. Green flashing: Output overloaded Yellow* flashing: Marginal excess gain (1.0 to 1.5x excess gain)		
Construction	ABS housing, rated IEC IP67; NEMA 6 3 mm mounting hardware included		
Connections	2 m (6.5') 4-wire PVC cable 9 m (30') 4-wire PVC cable	4-pin Pico-style QD 4-pin Pico-style 150 mm (6") pigtail QD	4-pin Euro-style QD 4-pin Euro-style 150 mm (6") pigtail QD
Operating Conditions	Temperature: -20° to +70° C (-4° to + 158° F) Relative Humidity: 90% @ 50° C (non-condensing)		
Certifications			

Dimensions and Features

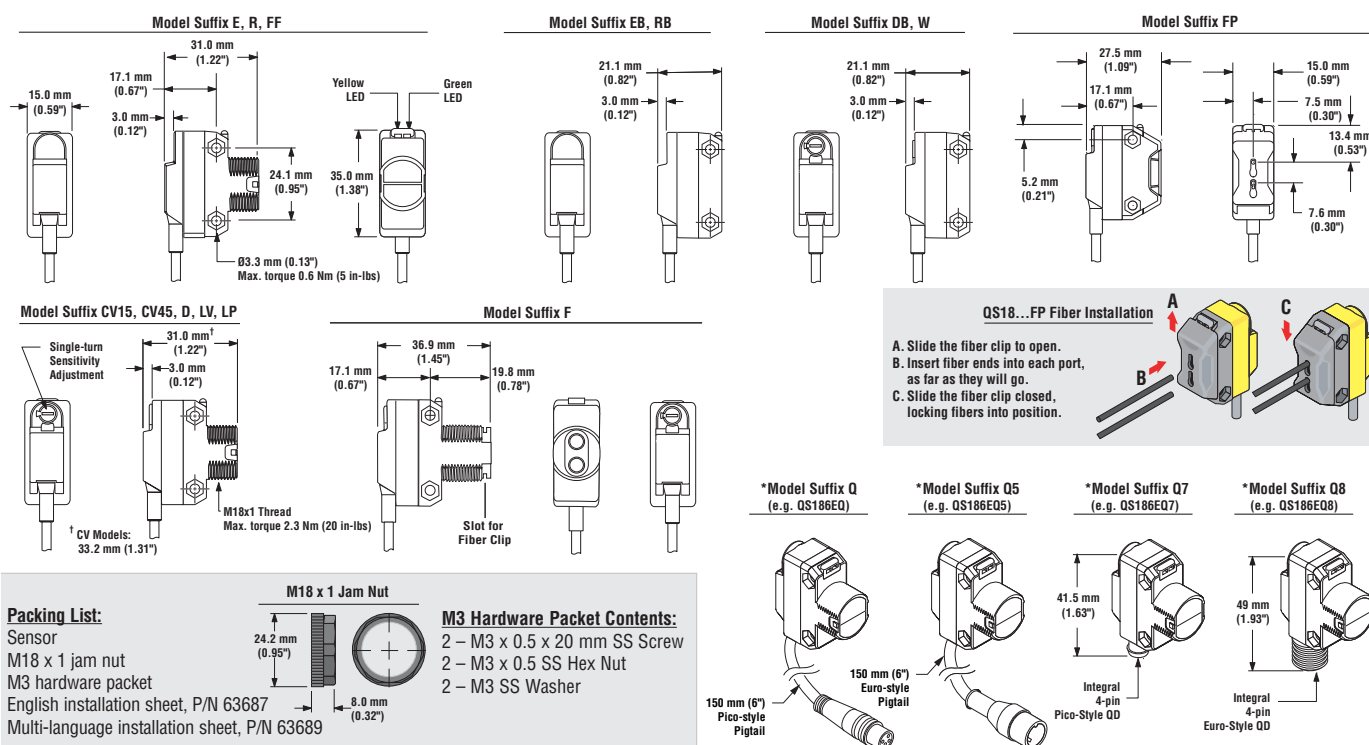

Performance Curves

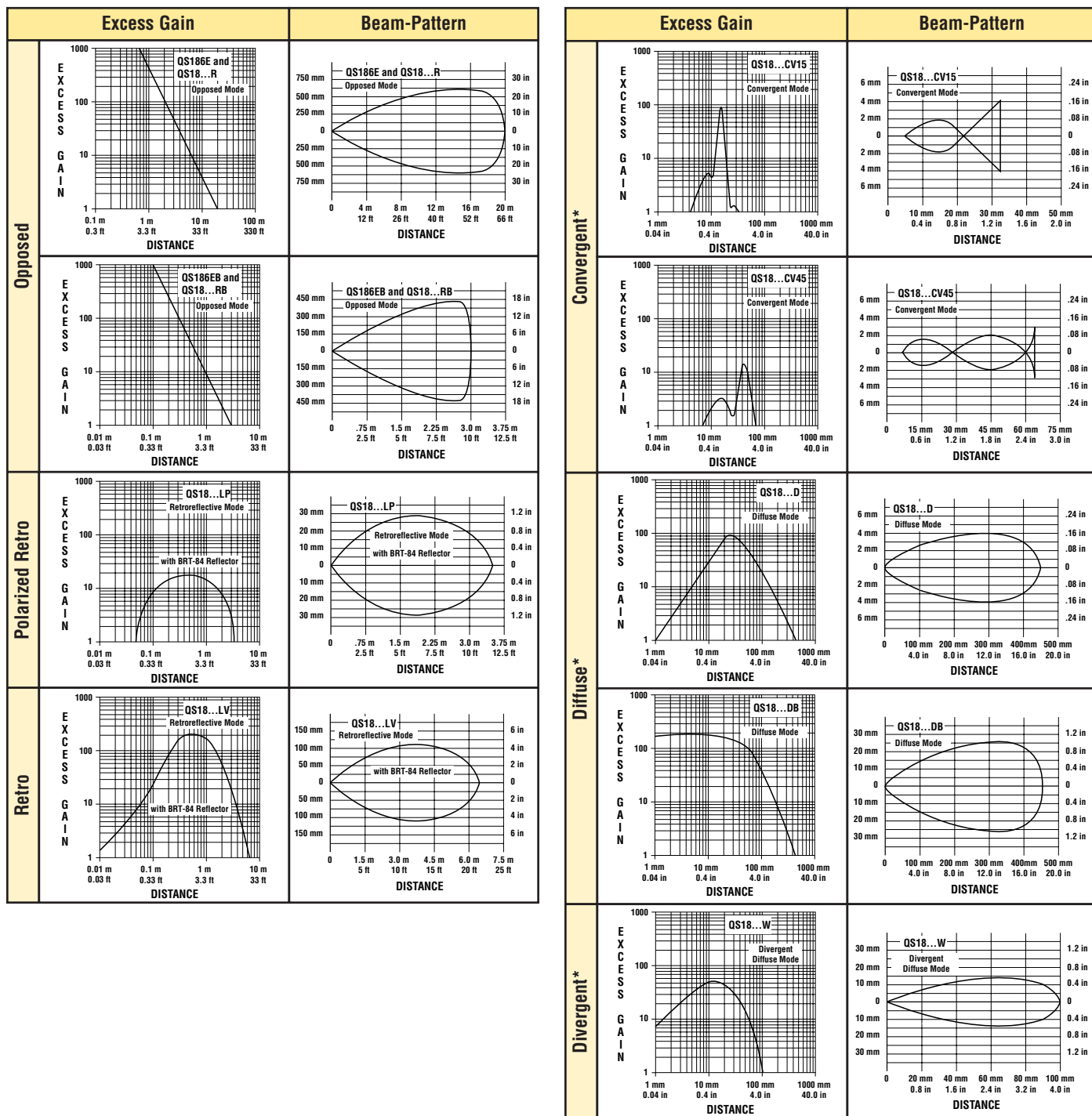

*Performance based on 90% reflectance white test card

Performance Curves, continued

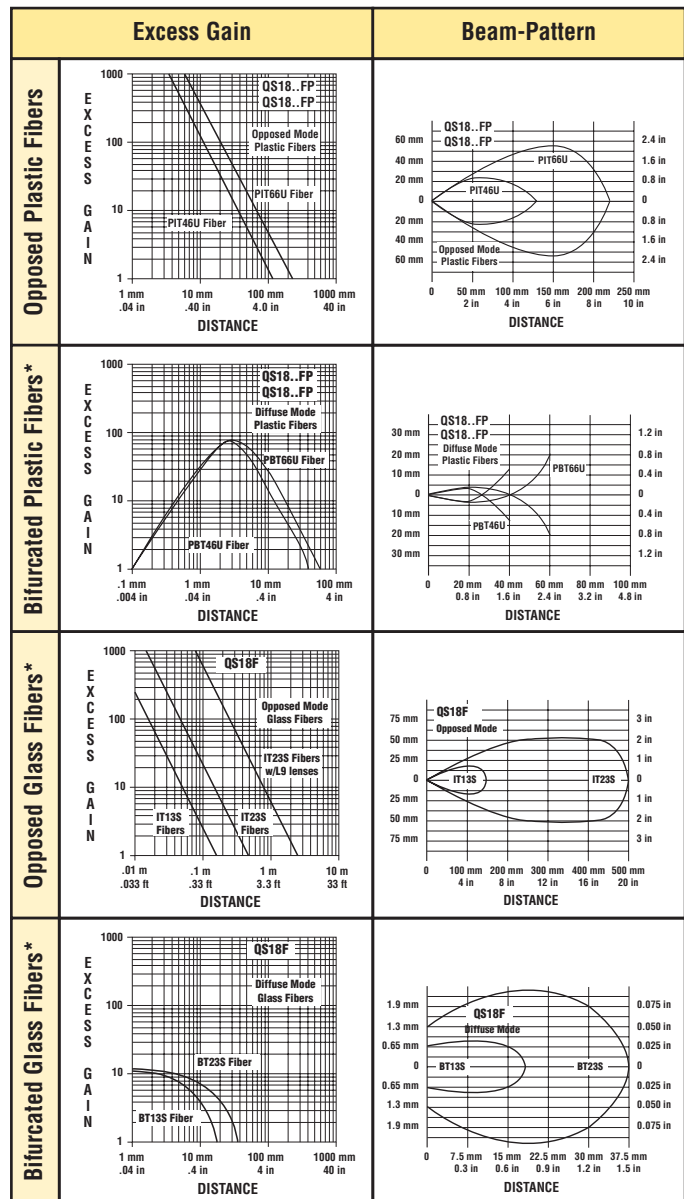
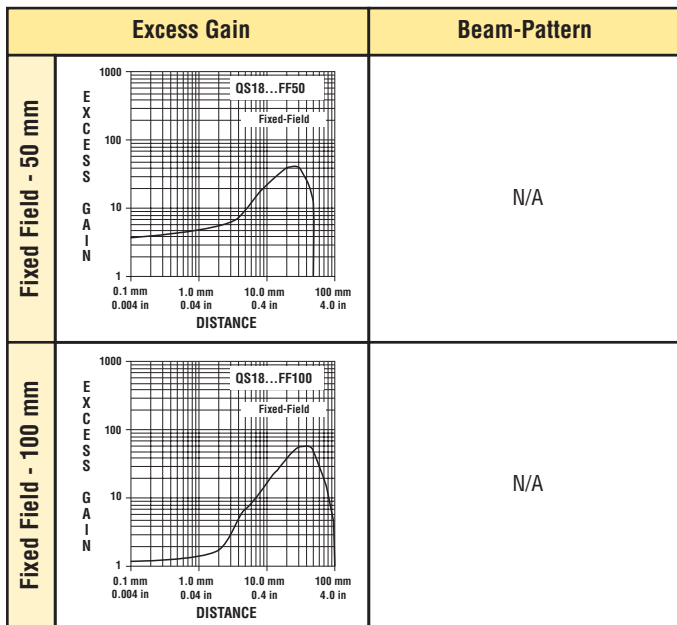

*Performance based on 90% reflectance white test card

Hookups

QS18 Sensors with NPN (Sinking) Outputs

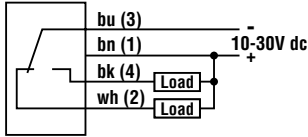

QS18 Sensors with PNP (Sourcing) Outputs

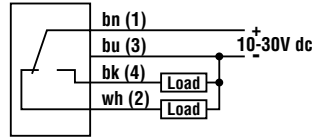

4-Pin Pico-Style Pin-out (Cable Connector Shown)

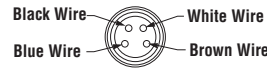

4-Pin Euro-Style Pin-out (Cable Connector Shown)

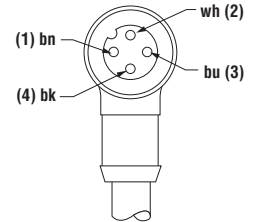

QS18 Emitters



Installing Fibers

Unterminated Plastic Fiber Cutting Procedure

Unterminated plastic fibers are designed to be cut by the user to the length required for the application. To facilitate cutting, a Banner model PFC-1 cutting device is supplied with the fiber. Cut the fiber as follows:

- 1) Locate the “control end” of the fiber (the unfinished end). Determine the length of fiber required for the application. If using a bifurcated fiber, separate the two halves of the fiber at least 2" beyond the fiber cutting location. Lift the top (blade) of the cutter to open the cutting ports. Insert one of the control ends through one of the cutting ports on the PFC-1 cutter so that the excess fiber protrudes from the back of the cutter.
- 2) Double-check the fiber length, and close the cutter until the fiber is cut. Using a different cutting port, cut the second control end to the required length. **To ensure a clean cut each time, do not use a cutting port more than once.**
- 3) Gently wipe the cut ends of the fiber with a clean, dry cloth to remove any contamination. **Do not use solvents or abrasives on any exposed optical fiber.**

Plastic Fiber Installation

- A) Unlock the fiber gripper as shown in Figure 2. If 0.25 mm or 0.5 mm core fibers are being used, slide the small fiber adapters onto the fibers, flush with the fiber ends.
- B) Gently insert the prepared plastic fiber ends into the ports, as far as they will go.
- C) Slide the fiber gripper back to lock, as shown in Figure 2.

Glass Fiber Installation

- A) Install the O-ring (supplied with the fiber) on each end, as shown in the drawing.
- B) While pressing the fiber ends firmly into the portson the front of the sensor, slide the U-shaped retaining clip (supplied with the sensor) into the slot in the sensor's barrel, until it snaps into place.

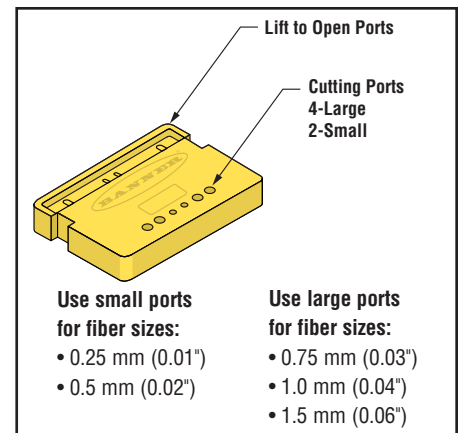

Figure 1. PFC-1 plastic fiber cutter (supplied with fiber)

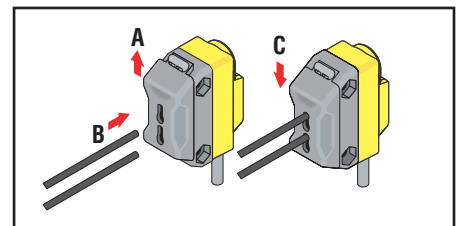

Figure 2. Installing plastic fibers

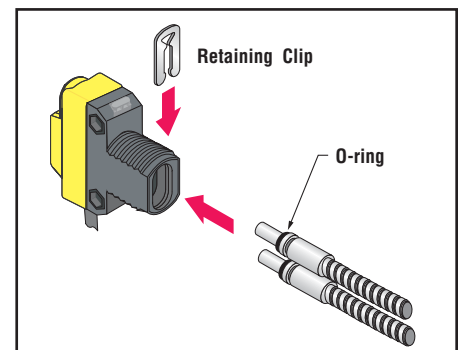

Figure 3. Installing glass fibers

WORLD-BEAM™ QS18

Euro-Style Quick-Disconnect Cables

Style	Model	Length	Dimensions
4-Pin Straight	MQDC-406 MQDC-415 MQDC-430	2 m (6.5') 5 m (15') 9 m (30')	
4-Pin Right-angle	MQDC-406RA MQDC-415RA MQDC-430RA	2 m (6.5') 5 m (15') 9 m (30')	

Pico-Style Quick-Disconnect Cables

Style	Model	Length	Dimensions
4-Pin Straight	PKG4-2	2 m (6.5')	
4-Pin Right-angle	PKW4-2	2 m (6.5')	

Retroreflective Targets

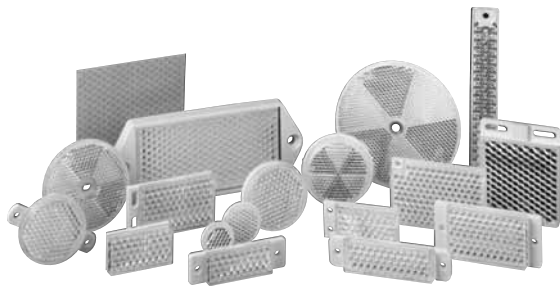

See the Accessories section of your current Banner Photoelectric Sensors catalog for complete information.

NOTE: Polarized sensors require corner cube type retroreflective targets only.

Plastic and Glass Fiber Optics

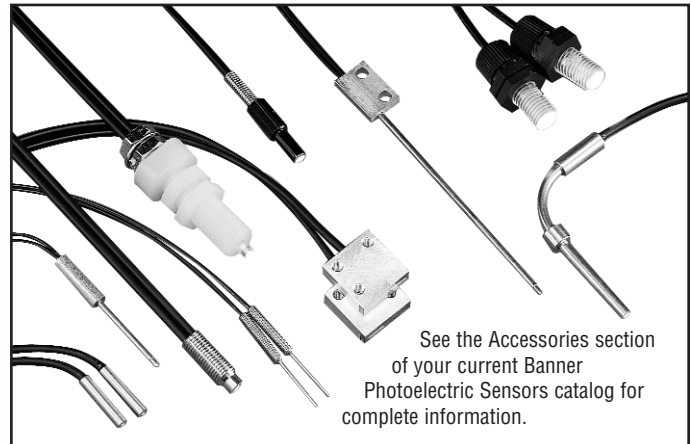

See the Accessories section of your current Banner Photoelectric Sensors catalog for complete information.

WORLD-BEAM QS18 Mounting Brackets

<p>SMB18A</p> <ul style="list-style-type: none"> • 12-gauge, stainless steel • Right-angle mounting bracket 	<p>SMB312S</p> <ul style="list-style-type: none"> • Stainless steel 2-axis, side-mounting bracket
<p>* Use 4 mm (#8) screws to mount bracket. Drill screw holes 24.2 mm (0.95") apart.</p> <p>Refer to your current Banner Photoelectrics catalog for more mounting bracket options</p>	

WORLD-BEAM™ QS18



WARRANTY: Banner Engineering Corp. warrants its products to be free from defects for one year. Banner Engineering Corp. will repair or replace, free of charge, any product of its manufacture found to be defective at the time it is returned to the factory during the warranty period. This warranty does not cover damage or liability for the improper application of Banner products. This warranty is in lieu of any other warranty either expressed or implied.



WARNING . . . Not To Be Used for Personnel Protection

Never use these products as sensing devices for personnel protection. Doing so could lead to serious injury or death.

These sensors do NOT include the self-checking redundant circuitry necessary to allow their use in personnel safety applications. A sensor failure or malfunction can cause either an energized or de-energized sensor output condition. Consult your current Banner Safety Products catalog for safety products which meet OSHA, ANSI and IEC standards for personnel protection.